

ALKAR Serpentine

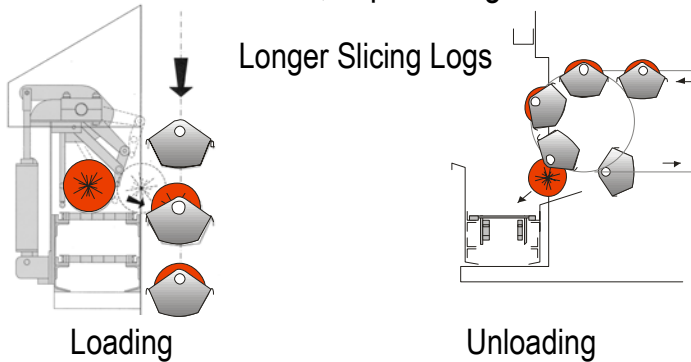

AUTOMATION

Eliminate labor; improve ergonomics



HIGH OUTPUT IN LESS FLOOR SPACE



SUPERIOR PRODUCT UNIFORMITY

- | | |
|-------------------|-------------|
| Sliced Lunch Meat | Ground Beef |
| Deli Logs | Molds |
| D-Shaped Product | Trays |
| Pizza Toppings | Liver Pate |
| Sausage Chubs | Ready Meals |

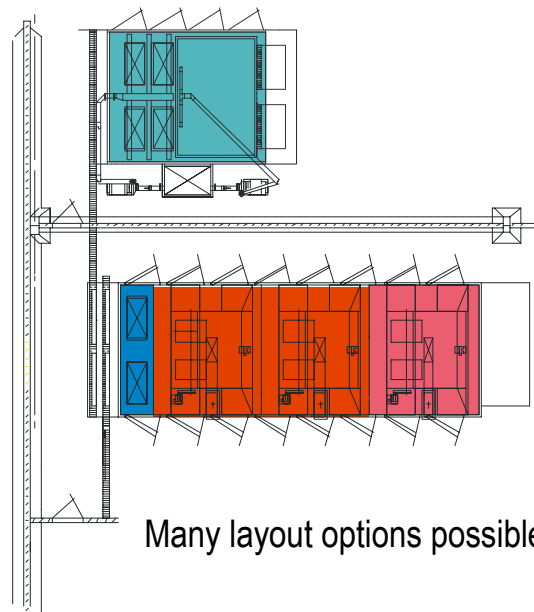

ALKAR Serpentine

CUSTOM DESIGNED

- Number of zones
- Number of loops
- Height
- Conveyor speed
- Cook zones
 - Water
 - Steam
 - Air
- Chill zones
 - Glycol
 - Brine
 - Water
 - Air

OPTIMIZED CARRIER DESIGNS

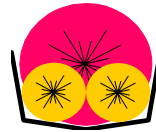

Versatile

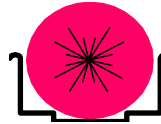

Cook



Chill



Shaping

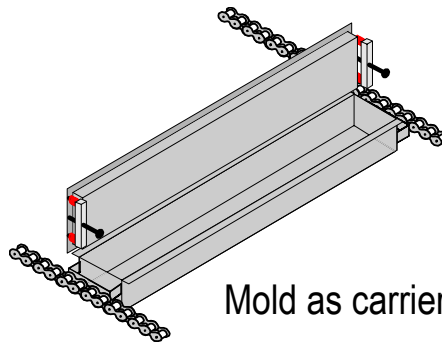

Mold as carrier

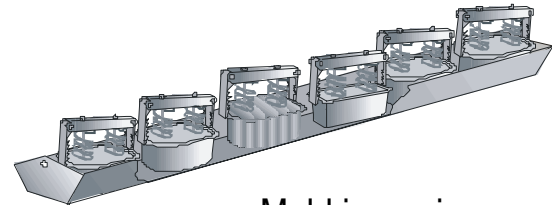

Mold in carrier

DEPENDABLE PERFORMANCE

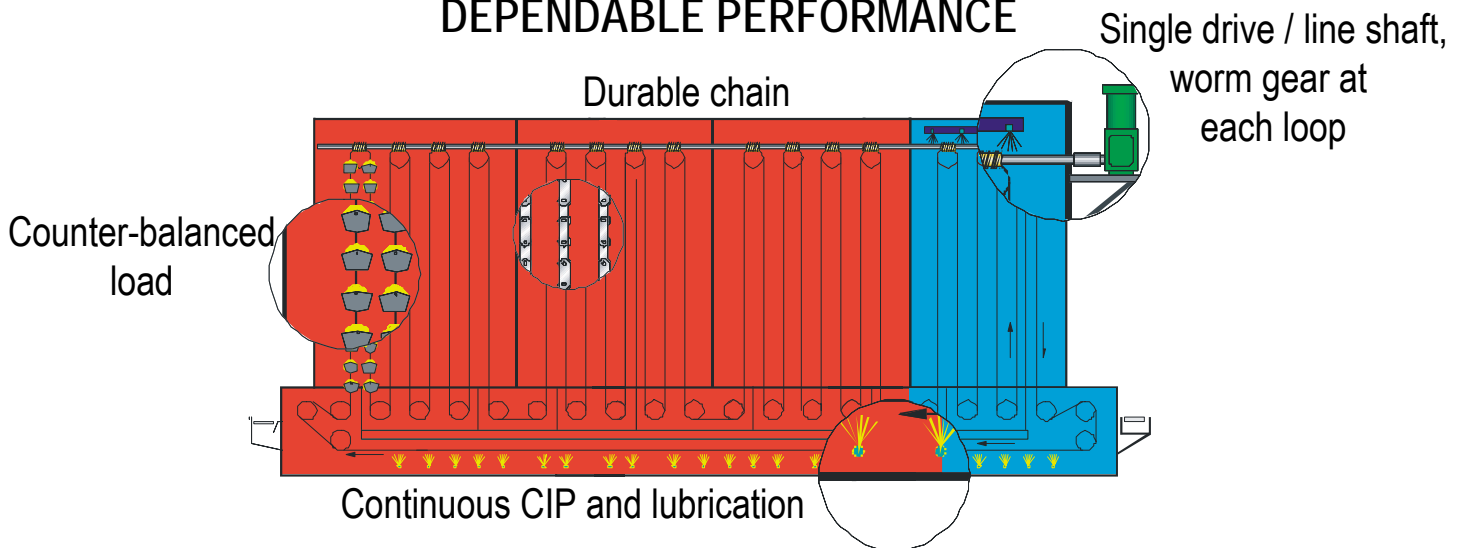

SUPERIOR UNIFORMITY

Serpentine product flow delivers higher slicing yields, longer shelf life, and greater profits

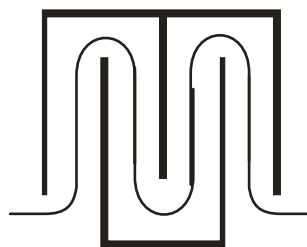
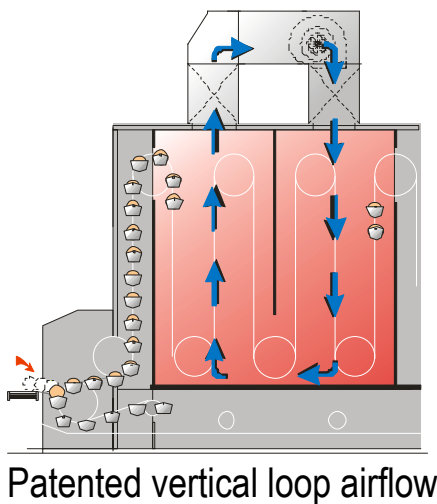

Isolated zones